

QTi 3X18 DIM

QUICKTRONIC INTELLIGENT DIM T8 | ECG dimmable 1...10 V for FL 26 mm



Areas of application

- Suitable for use in emergency lighting systems as per EN 50172/DIN VDE 0108-100
- Installation in emergency lighting systems according to IEC 61347-2-3, appendix J
- Industry
- Open-plan offices, corridors and storage rooms
- Public buildings
- Suitable for luminaires of protection class I

Product benefits

- Same luminous flux with direct and alternating current
- Perfect lamp start for applications with motion sensors
- Dimming of amalgam lamps without flickering or reduced lifespan
- Very high efficiency thanks to cut-off technology
- Automatic restart after lamp replacement
- ECGs comply with MINERGIE standard due to very low standby consumption
- Configurable emergency power characteristics
- Control via the 1...10 V interface

Product features

- Control via 1...10 V interface
- Supply voltage: 220...240 V
- Line frequency: 0 Hz | 50 Hz | 60 Hz
- Line voltage: 198...264 V
- Dimming range: 1...100 % luminous flux
- Lamp start: within 0.6 s
- Lifetime: > 100,000 h (for T = 65 °C at T_c)
- Automatic shutdown of defective lamps and at end of life (EoL T.2)
- Energy Efficiency Index EEI: A1 BAT
- Overtemperature protection: Thermal management at high t_c temperatures
- Safety: to EN 61347-2-3
- Lamp operation: to EN 60929

Product datasheet

- RI suppression: to EN 55015:2006+A1:2007+A2:2009/CISPR 15
- Line harmonics according to EN 61000-3-2
- Immunity according to EN 61547

Technical data

Electrical data

Input voltage AC	198...264 V
Nominal voltage	220...240 V
Mains frequency	50/60 Hz
Input voltage DC	154...276 V
Operating frequency	40...100 kHz
Max. ECG no. on circuit breaker 10 A (B)	12 ¹⁾
Max. ECG no. on circuit breaker 16 A (B)	19 ¹⁾
Inrush current	35 A

¹⁾ Type B

Light technical data

Starting time	0.6 s ¹⁾
---------------	---------------------

¹⁾ Optimized preheat start

Dimensions & weight

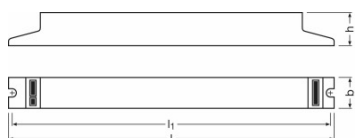

Length	360.0 mm
Width	40.0 mm
Height	21.0 mm
Mounting hole spacing, length	350.0 mm
Product weight	390.00 g
Wire preparation length, input side	8.0...9.0 mm ¹⁾
Wire preparation length, output side	8.0...9.0 mm ¹⁾
Cable cross-section, output side	0.5...1.5 / 0.5...1.0 mm ² ²⁾
Cable cross-section, input side	0.5...1.5 / 0.5...1.0 mm ² ²⁾

¹⁾ Combi wiring

²⁾ Solid leads / Flexible

Temperatures & operating conditions

Ambient temperature range	-20...+50 °C
Permitted rel. humidity during operation	5...85 %

Lifespan

ECG lifetime	100000 h ¹⁾
---------------------	------------------------

¹⁾ At tcase = 65°C at tc point / 10 % failure rate

Capabilities

Dimming interface	1...10 V
Dimming range	1...100 % ¹⁾
Dimmable	Yes
Overload protection	Automatic switch off, reversible
Overheating protection	Power reduction and switch off at T > 75 °C at the tc point
Suitable for fixtures with prot. class	I
End of lamp life safety shutdown	EOL T.2

¹⁾ Luminous flux

Certificates & standards





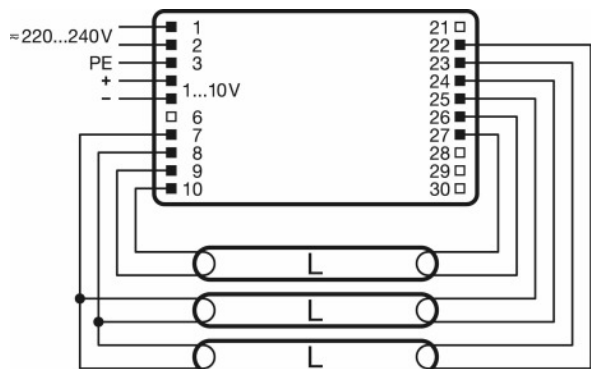





Approval marks – approval	VDE / E1 approval / VDE-EMC
EEI – Energy Label	A1 BAT
Standards	Acc. to EN 61347-2-3/Acc. to EN 60929/Acc. to EN 55015:2006 + A1:2007/Acc. to EN 61000-3-2/Acc. to EN 61547
Protection class	I

Wiring Diagram







Wiring diagram

[Download Data](#)

File	
	Addon Technical Information Frequent switching Quicktronic
	Addon Technical Information ECG lifetime - QUICKTRONIC (DALI) DIM
	Certificates EMC-Marks approval
	Certificates INOTEC
	Certificates ENECVDE-Marks approval
	Certificates Manufacturer's declaration LampECG combinations: Frequent switching
	Certificates VDE-EMC-CERTIFICATE QT DALI DIM
	Certificates EAC certificate for Quicktronics QT
	Declarations of conformity Declaration of conformity
	Installation/Operation notice Technical application guide QUICKTRONIC Intelligent DALI DIM (GB)

Product datasheet

	Operating instructions EAC QTi T8 DIM
	CAD data 3-dim QTi 3x18220-240 DIM
	CAD data 3-dim QTi 3x18220-240 DIM
	CAD data 3-dim QTi 3x18220-240 DIM
	CAD data PDF QTi 3x18220-240 DIM

Logistical Data

Product code	Product description	Packaging unit (Pieces/Unit)	Dimensions (length x width x height)	Volume	Gross weight
4008321069931	QTi 3X18 DIM	Shipping carton box 20	384 mm x 90 mm x 210 mm	7.26 dm ³	8072.00 g

The mentioned product code describes the smallest quantity unit which can be ordered. One shipping unit can contain one or more single products. When placing an order, for the quantity please enter single or multiples of a shipping unit.

Disclaimer

Subject to change without notice. Errors and omission excepted. Always make sure to use the most recent release.

QTi 3X18 DIM

QUICKTRONIC INTELLIGENT DIM T8 | ECG dimmable 1...10 V for FL 26 mm

Product name	Lamp group	Nominal current	Nominal wattage + Power loss	Luminous flux at 35 °C	Number of lighting outlets
ZMP_56688 QTi DIM T8 L DUL 3 220-240V	DULUX F 18 W	0.24 A	53.60 W	1100 lm	3
	DULUX L 18 W	0.24 A	53.60 W	1200 lm	3
	L 18 W	0.24 A	53.60 W	1350 lm	3
	L 18 W XT	0.24 A	53.60 W	1350 lm	3
	L 18 W XXT	0.24 A	53.60 W	1350 lm	3