



HF-Performer III for TL5 lamps

HF-P 254/255 TL5 HO/PLL III 220-240V IDC

HF-Performer III TL5 ballasts offer maximum versatility and meet all of the necessary commercial grade specifications. They also offer the added benefits of lamp striation reduction technology, making these ballasts compatible with energy-saving TL5 ECO lamps. As such, these ballasts are part of an overall high-efficiency lighting system that may help you or your customers to achieve any international or local energy code you need to comply with. HF-Performer III TL5 ballasts are the ideal choice for a broad range of new construction and retrofit applications within the commercial sector, including general surface mounting or office lighting, parking garages, warehouses, waterproof and other applications. The ballast is primarily designed for Indoor application. For outdoor application, the luminaire should be minimum Classland need to be sufficiently protected against water & dust. The installation should also be guard against any lightening surge or any other necessary electrical protection as deemed in such typical installation & application.

Product data

Operating and Electrical		Wiring	
Input Voltage	220 to 240 V	Connector Type Input Terminals	WAGO 251 universal connector [Suitable for both automatic wiring (ALF and ADS) and manual wiring]
Line Frequency	50 to 60 Hz	Connector Type Output Terminals	WAGO 251 universal connector [Suitable for both automatic wiring (ALF and ADS) and manual wiring]
Input Frequency	50 to 60 Hz		
Inrush Current Width	0.35 ms		
Inrush Current Peak (Max)	31 A		
Number of Products on MCB (16A Type B) (Nom)	12		
		Temperature	
		Ambient temperature range	-25 °C to 60 °C
		T-Case Lifetime (Nom)	80 °C

HF-Performer III for TL5 lamps

T-Case Maximum (Max)	80 °C
Mechanical and Housing	
Housing	L360x30x22
Approval and Application	
Ingress protection code	IP20 [Finger-protected]
Energy Efficiency Index	A2 BAT
Safety Standard	IEC 61347-2-3
Environmental Standard	ISO 14001
Approval Marks	CE marking ENEC certificate VDE-EMV certificate

Product Data	
Order product name	HF-P 254/255 TL5 HO/PLL III 220-240V IDC
Full product name	HF-P 254/255 TL5 HO/PLL III 220-240V IDC
Full product code	872790086351200
Order code	913713028366
Material Nr. (12NC)	913713028366
Numerator - Quantity Per Pack	1
EAN/UPC - Product/Case	8711500998224
Numerator - Packs per outer box	12
EAN/UPC - Case	8727900863512

Dimensional drawing

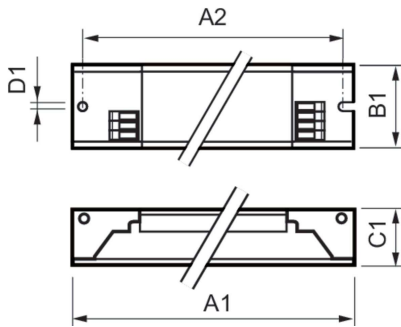

Product	D1	C1	A1	A2	B1
HF-P 254/255 TL5 HO/PLL III 220-240V IDC	4.2 mm	22.0 mm	360.0 mm	350.0 mm	30.0 mm

