



CorePro LED PLC 4P



CorePro LED PLC 9W 840 4P G24q-3

The CorePro LED PLC 4P integrates a LED light source into a traditional fluorescent form factor. This product is the ideal solution for uplamping in general lighting applications: it meets basic lighting requirements, offers significant energy savings, and is environmentally friendly.

Product data

General Information	
Cap-Base	G24Q-3 [G24q-3]
Nominal lifetime	30,000 hour(s)
Switching Cycle	50,000
Lighting Technology	LED
Flux measurement reference	Sphere
Light Technical	
Color Code	840 [CCT of 4000K]
Beam Angle (Nom)	120 degree(s)
Luminous Flux	1,000 lumen
Color Designation	Cool White (CW)
Correlated Color Temperature (Nom)	4000 K
Luminous Efficacy (rated) (Nom)	100.00 lm/W
Color Consistency	<6
Color rendering index (CRI)	83
LLMF At End Of Nominal Lifetime (Nom)	70 %
Operating and Electrical	
Line Frequency	30000-80000 Hz
Input Frequency	30000-80000 Hz
Power Consumption	9 W
Starting Time (Nom)	0.5 s

Warm-up time to 60% light	0.5 s
Power Factor (Fraction)	0.9
Voltage (Nom)	20-50 V
Temperature	
Ambient temperature range	-20 °C to 35 °C
T-Case Maximum (Nom)	76 °C
Controls and Dimming	
Dimmable	No
Mechanical and Housing	
Product Length	200 mm
Bulb Shape	Tube, single-ended
Approval and Application	
Energy Efficiency Class	F
Energy Saving Product	Yes
Approval Marks	TUV CE marking RoHS compliance KEMA Keur certificate
Energy Consumption kWh/1000 h	9 kWh
EPREL Registration Number	403551
CE mark	Yes

CorePro LED PLC 4P

EU RoHS compliant	Yes
Product Data	
Full product code	871869654117300
Order product name	CorePro LED PLC 9W 840 4P G24q-3
Order code	929001200902
Numerator - Quantity Per Pack	1

Numerator - Packs per outer box	10
Material number (12NC)	929001200902
Full product name	CorePro LED PLC 9W 840 4P G24q-3
EAN/UPC - Case	8718696541180

Dimensional drawing

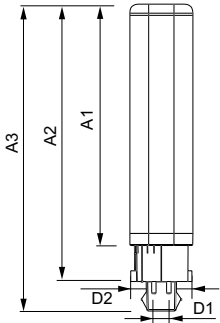

Product	D1	D2	A1	A2	A3
CorePro LED PLC 9W 840 4P G24q-3	24.3 mm	28.4 mm	128.8 mm	148 mm	163.6 mm

Photometric data

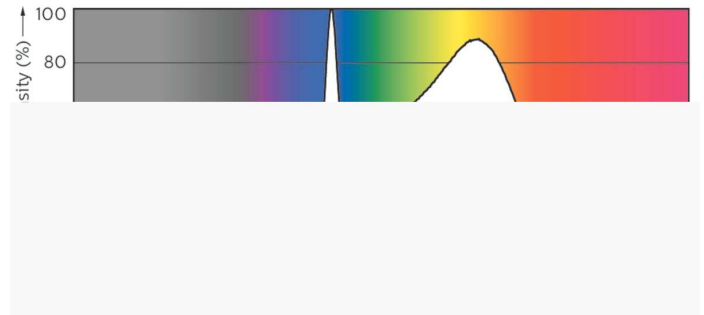
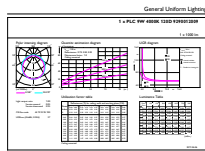

General uniform lighting - CorePro LED PLC 9W 840 4P G24q-3

Spectral Power Distribution Colour - CorePro LED PLC 9W 840 4P G24q-3

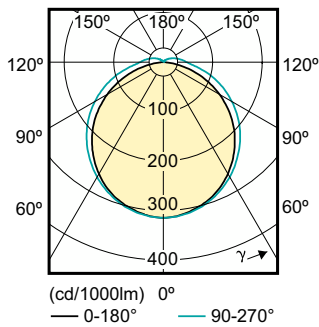

Light Distribution Diagram - CorePro LED PLC 9W 840 4P G24q-3

CorePro LED PLC 4P

Lifetime

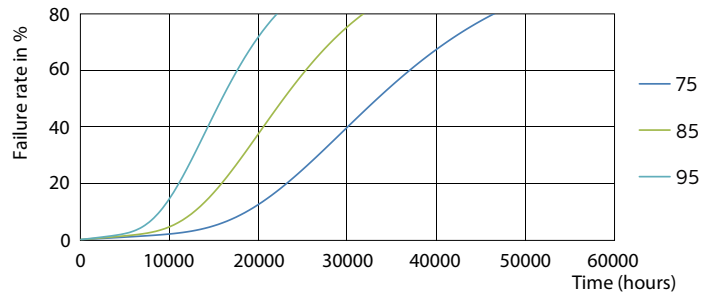
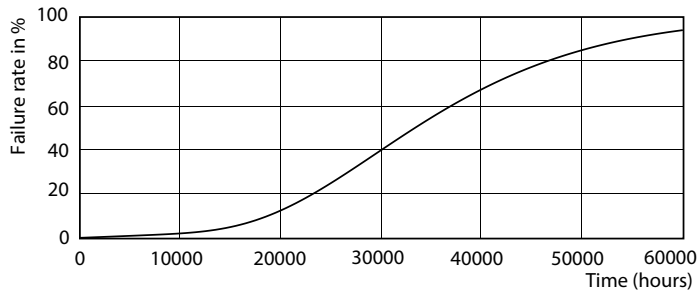

Life Expectancy Diagram - CorePro LED PLC 9W 840 4P G24q-3

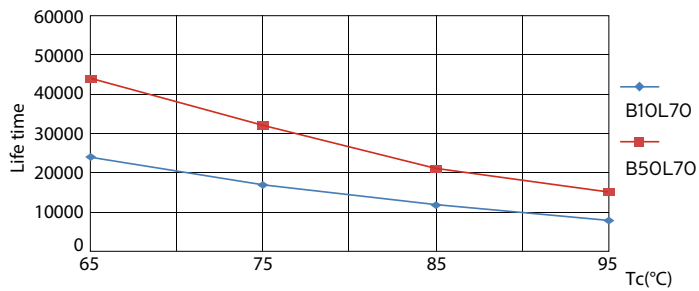

Life Expectancy Diagram - CorePro LED PLC 9W 840 4P G24q-3

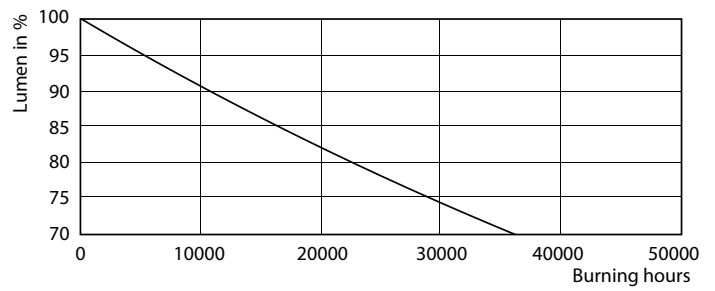

Life Expectancy Diagram - CorePro LED PLC 9W 840 4P G24q-3

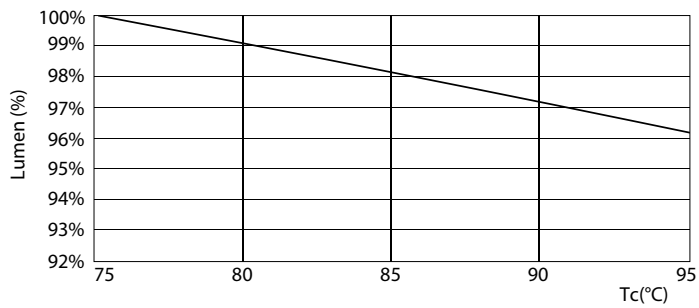

Lumen Maintenance Diagram - CorePro LED PLC 9W 840 4P G24q-3

Lumen Maintenance Diagram - CorePro LED PLC 9W 840 4P G24q-3

CorePro LED PLC 4P

